

Actuator Experts

Engineering Precision For Global Flow Control

Discover GREATORK



Intelligent Control. Precise Every Degree



Pipeline Gas In. Hydraulic Force Out



Hydraulic Power. Electric Precision



COMPLETELY REPLACEMENTABLE

Non-Intrusive Setting
Protection & Safety
Communication & Control
Pipeline control
Emergency Shutdown (ESD)





Discover GREATORK 

ABOUT US

Tefulong Group Co., Ltd

Tefulong Group Co., Ltd. is a leading intelligent electric valve actuator manufacturer in China with the brand name of Greatork.

Tefulong Group Co., Ltd., established in 1987, covers an area of 40,000 square meters, and owns modern management style, first-class factory and advanced production equipments. With more than 300 employees, Tefulong produces about 50,000 pcs of electric actuators per year. At present, actuators have been supplied GREATORK into more than 20 countries. The intelligent electric actuators are our key products and widely applied in oil & gas, petrochemical, refinery, power plant, water process, wastewater treatment, pulp & paper, and other major industries. THE WORLD LEADER IN ACTUATION SOLUTION

Tefulong has obtained many certificates for international market, such as **CE, ATEX, IP68, GOST, ISO14001, ISO9001, GB/T 28001**, Profibus communication certificate and so on.

Meanwhile, Greatork has unique Industrial Design Patent which is recognized and protected around the world. We have a team of qualified, experienced and talented researchers & engineers with wide variety of backgrounds in R&D centre. We are committed to keeping efforts to ensure that our actuators are the simplest to operate and the highest reliable to work with.

Our mission is to provide the industry with high-quality and cost-effective electric actuators and maximize customer's value. We persist on continuous improvement and product innovation to keep our competitiveness.



Quality First, Users First

GREATORKPARTNERS

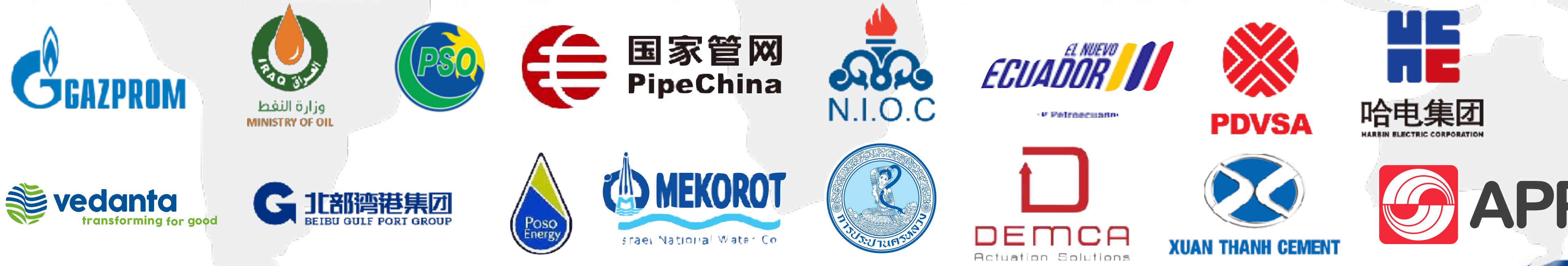
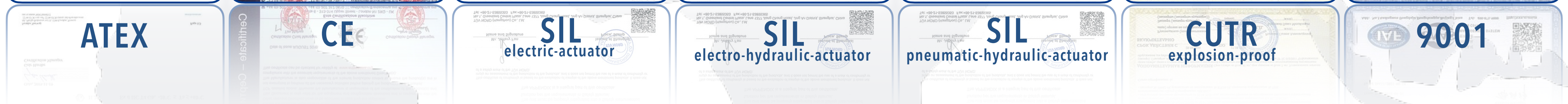

At present, products have been supplied into more than **80** countries



GREATORK TECHNOLOGY

INNOVATION IN AUTOMATION

Start Exploring >

30+

Engineers
Full Lifecycle
Technical Support

300+

Professional Employees
Efficient Production
& Close Collaboration

50000+

Annual Production Capacity
Strict Quality Control System

80+

Global Market
Coverage in 80+ Countries

GREATORK Electric Actuator Product Family

Intelligent Control Precise Every Degree

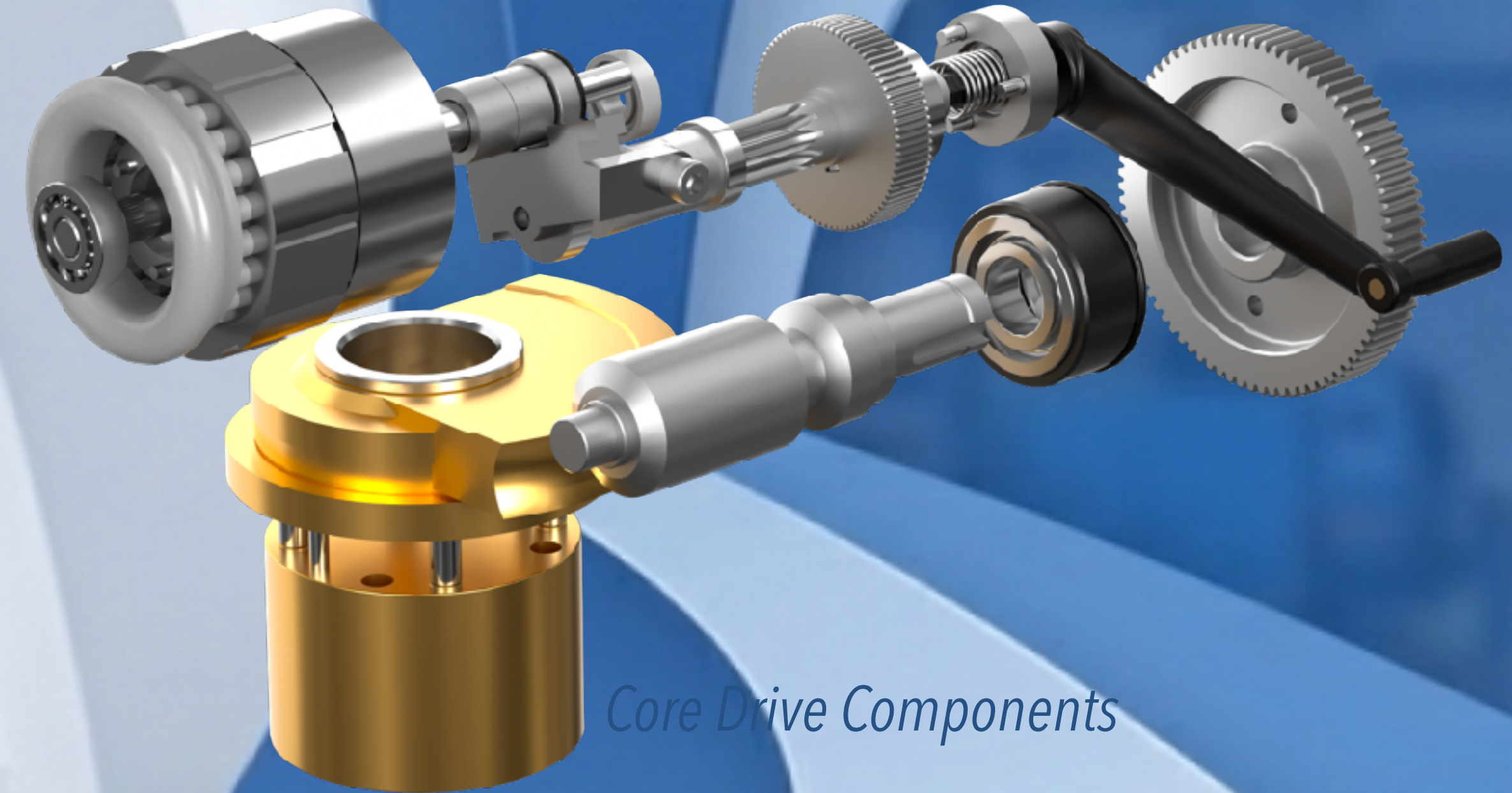

Core Drive Components

AVAMD Linear



AVAT Quarter-turn



AVAR Smart Quarter-turn



AVA Multi-turn



Industry-Specific Solutions

GREATORK Products are Widely Applied in Major Industries:

Oil & Gas, Petrochemical, Refinery, Power Plants, Water Process, Wastewater Treatment, Pulp & Paper, and Other Critical Sectors.



Key Automation Control Scenarios:

Pipeline Transportation, Station Protection, Emergency Shutdown, Remote Monitoring.

Specific Applications Include Long-Distance Pipelines, Compressor Load/Unload Protection, Station Blowdown, Line Break Protection, River Crossing Valve Rooms.

Core Performance Attributes:

Reliable Performance in Harsh Environments, High Precision Control, Advanced Communication Capabilities.



GREATORK Electric Actuator Product Series

Core Product Series AVA/AVAT/AVAR/AVAMD

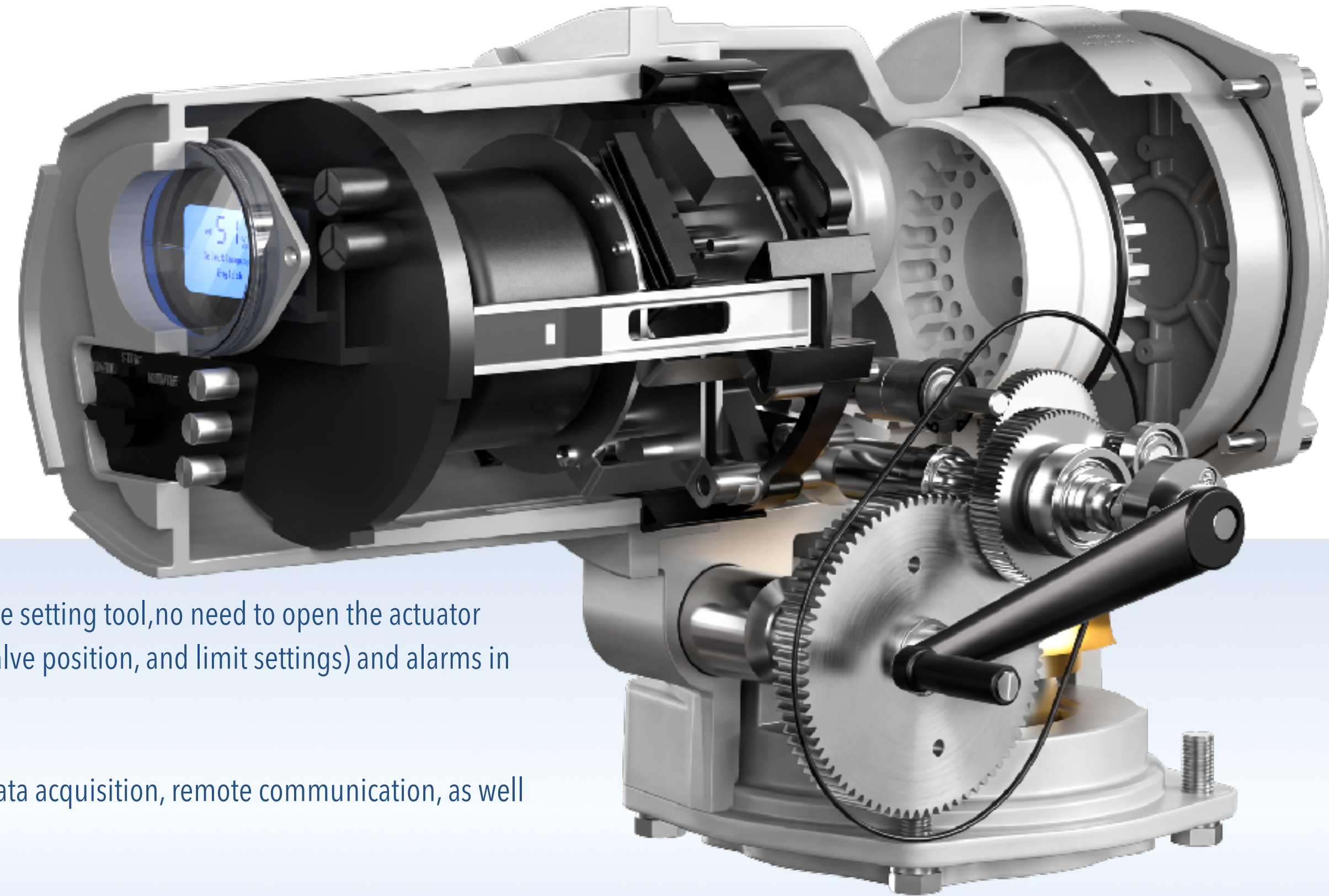
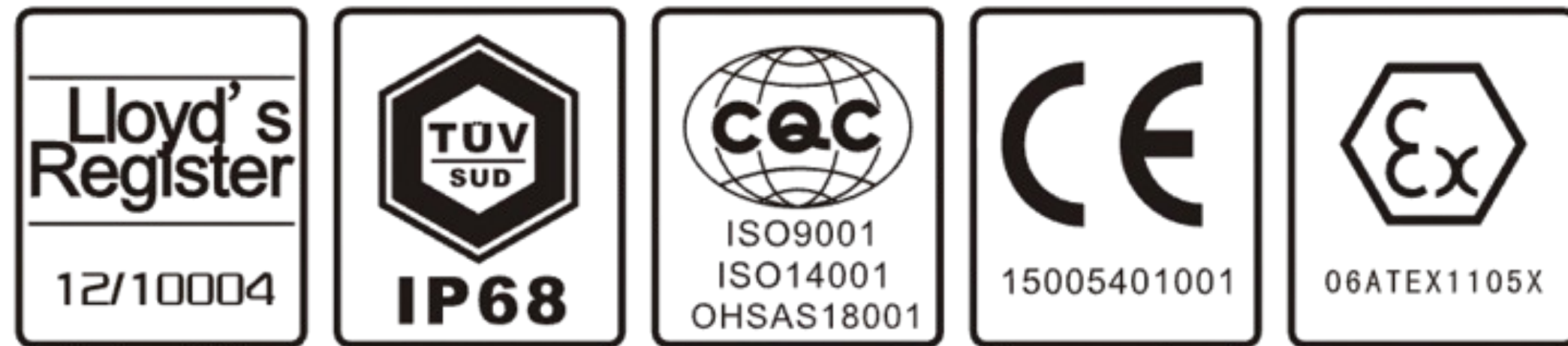

AVAT
Quarter-turn
Electric Valve Actuator

The AVA/AVAT/AVAR series electric actuators can be quickly configured, inspected, and queried non-intrusively via a standalone setting tool, no need to open the actuator cover. These actuators are equipped with a graphic dot-matrix LCD display, which shows operating statuses (such as torque, valve position, and limit settings) and alarms in text, numeric, and graphic formats. This significantly facilitates user operation and usage.

With a fieldbus communication card, they can form a fully distributed computer cooperative work system, enabling remote data acquisition, remote communication, as well as remote diagnosis and maintenance.

The actuators feature automatic protection and flame proof functions. Actuator has IECEx/ ATEX explosion-proof certificate and SIL functional safety certificate, suitable for hazardous areas. The actuator is widely used in industries such as petroleum, power, metallurgy, and water treatment, and is a reliable choice for global industrial applications.

Intelligent Electric Valve Actuator Internal Structure

Torque measurement

Greatork actuator, which adopts precise pressure sensor, can have fast and accurate detecting of output shaft torque.

Motor and Drive

Greatork three-phase squirrel-cage asynchronous motor designed by advanced special software can work in extreme environments with F class insulation. The motor shaft and worm shaft are separate in order to facilitate rapid replacement. Worm and worm shaft are immersed in lubricant to fit temperature change.

Terminal Compartment

Separately sealed terminal compartment can make sure of the integrity of the electrical control part even when the terminal compartment cover is removed for site wiring.

Thrust Base

Models below AVA06 are fitted with lubricated, removable type 'A' thrust base. Actuators can be removed without changing valve position. AVA07 and above models' thrust bases are integrated with enclosure. Simple and removable drive bushing can be machined to fit valve stem.

Manual operation

The handwheel (or independently geared handwheel on larger size) can be directly driven with low speed padlockable hand/ auto clutch to provide reliable emergency manual operation in the event of a power supply failure. Manual operation has lost motion "hammerblow" effect, which will facilitate easy valve operation.

Valve position Control

Greatork discards traditional potentiometer to measure valve position and introduce hall incremental encoder to improve the position accuracy. Optical absolute encoder as the option can record the valve position accurately without battery when the power is off.

Infrared setting

Infrared setting tool can set and diagnose actuator through sealed indication window without removing the electric cover. The communication distance between setting tool and window is within 0.75 meter.

Local Control

Local control switch (Local/Stop/Remote) and pushbuttons are magnetic switches without penetrating shafts and control the actuator by internal magnetic reed. It can meet the requirements of tight seal and damp-proof.

Note: The switch can be locked at Local/Stop/Remote position by padlock to prohibit unnecessary local control.

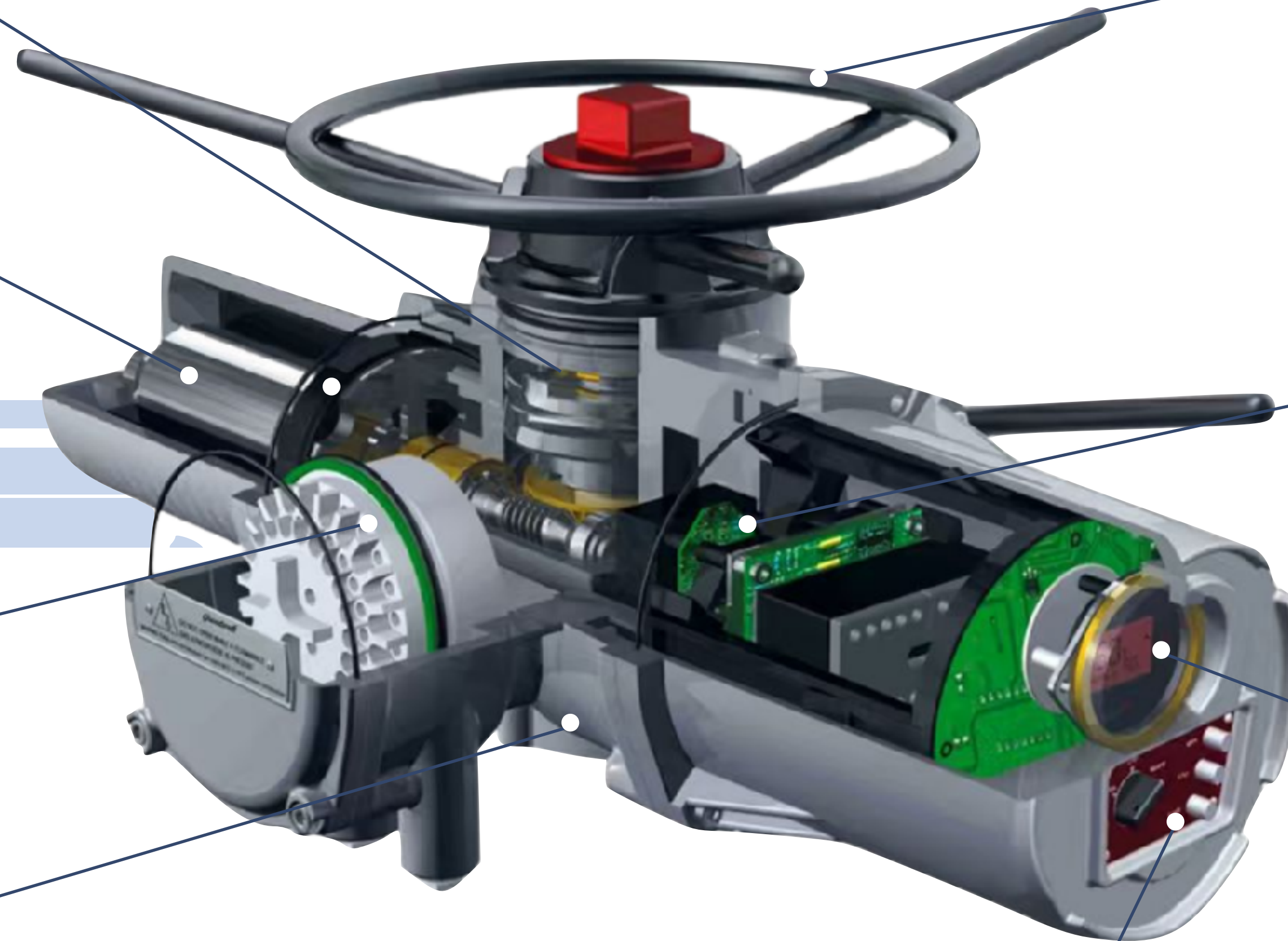

Electric Actuator Functions and Features

Double-Sealed structure

The Greatork AVA/AVAT range actuators feature a double - sealed, watertight metallic enclosure that meets IP68 standards (15 meters underwater for 90 hours). Explosion - proof ratings of BT4 and CT4 are optional. The terminal compartment and the internal electrical control parts are entirely separate. Even when the terminal compartment cover is removed for on - site wiring, the internal electrical control parts remain waterproof and dustproof.

Reliable electronic system

The electronic systems of Greatork actuators use an advanced 32 - bit embedded SOC chip, which provides strong computing power and integrates multifunctional circuits. It integrates all necessary electronic circuits and component parts without complex electrical wiring, ensuring high reliability for electronic control.

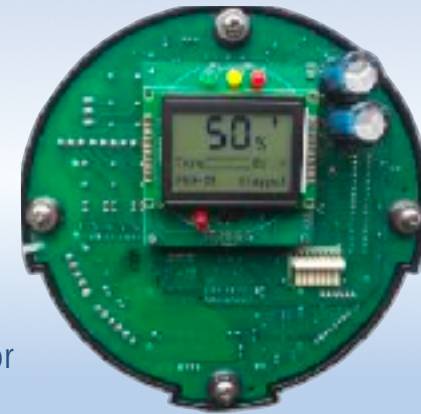

Precise valve position measurement

AVA/AVAT range actuator takes an advanced Hall - effect incremental encoder to measure the valve position. The adoption of a non - contact encoder design can avoid the disadvantages of the traditional potentiometer, which is easy to wear and has a short life. It increases the reliability and lifetime of the actuator. The setting range of the encoder is 2.5~150,000,000 revolutions. For the AVA multi - turn actuator, the output angle resolution of the central axis is 7.5 degrees. For the AVAT part - turn actuator, the output angle resolution of the central axis is 0.05 degrees.

The AVA/AVAT range actuator can take a 24 - bit optical absolute encoder as an option. This kind of encoder uses an optical encoder disk to accurately record the valve position without a battery when the power is off. For the AVA multi - turn actuator, the output angle resolution of the central axis is 0.2° with a maximum of 1024 revolutions. For the AVAT part - turn actuator, the output angle resolution of the central axis is 0.02°.



Infrared setting

AVA/AVAT series actuators adopt advanced infrared remote control technology (IrDA). The infrared setting tool enables actuator setup and diagnosis via a sealed indicator window—no need to remove the electric cover. The communication distance between the tool and window is within 0.75 meters. The infrared setting tool features intrinsically safe design and can be used in hazardous environments.



Non-intrusive design

The Greatork AVA/AVAT range actuators adopt a non - intrusive design. Site setting can be done with an infrared setting tool without removing the electric cover, protecting internal electrical control parts from site pollution. Local operation design abandons traditional moving shafts penetrating the control enclosure and uses hall magnetic sensor technology to control the actuator.

Accurate torque measurement (Patented)

Greatork uses its patented torque measurement system to ensure actuator overload protection and indicate torque variation via LCD. The precise torque value is determined by the electronic signal converted from the reaction force of the motor shaft's thrust (transferred by the torque sensor), solving the problem of calculating torque based on power frequency, voltage and temperature changes.

High-definition LCD

Greatork actuators integrate a unique high - definition LCD. Its large backlit display window allows users to view valve position, torque and functional status from a long distance.

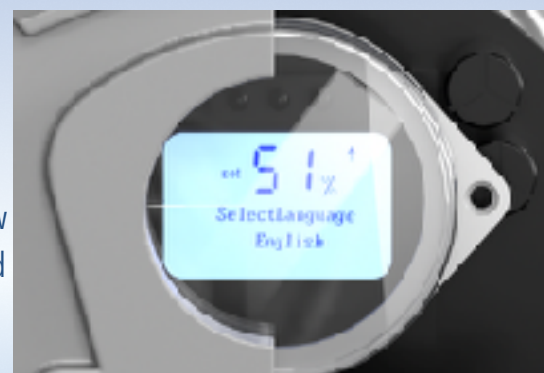

Duty cycle

Duty cycle covers S2 to S4.

Noise

Independent tests have shown that the noise did not exceed 61dB (A) within 1M distance.

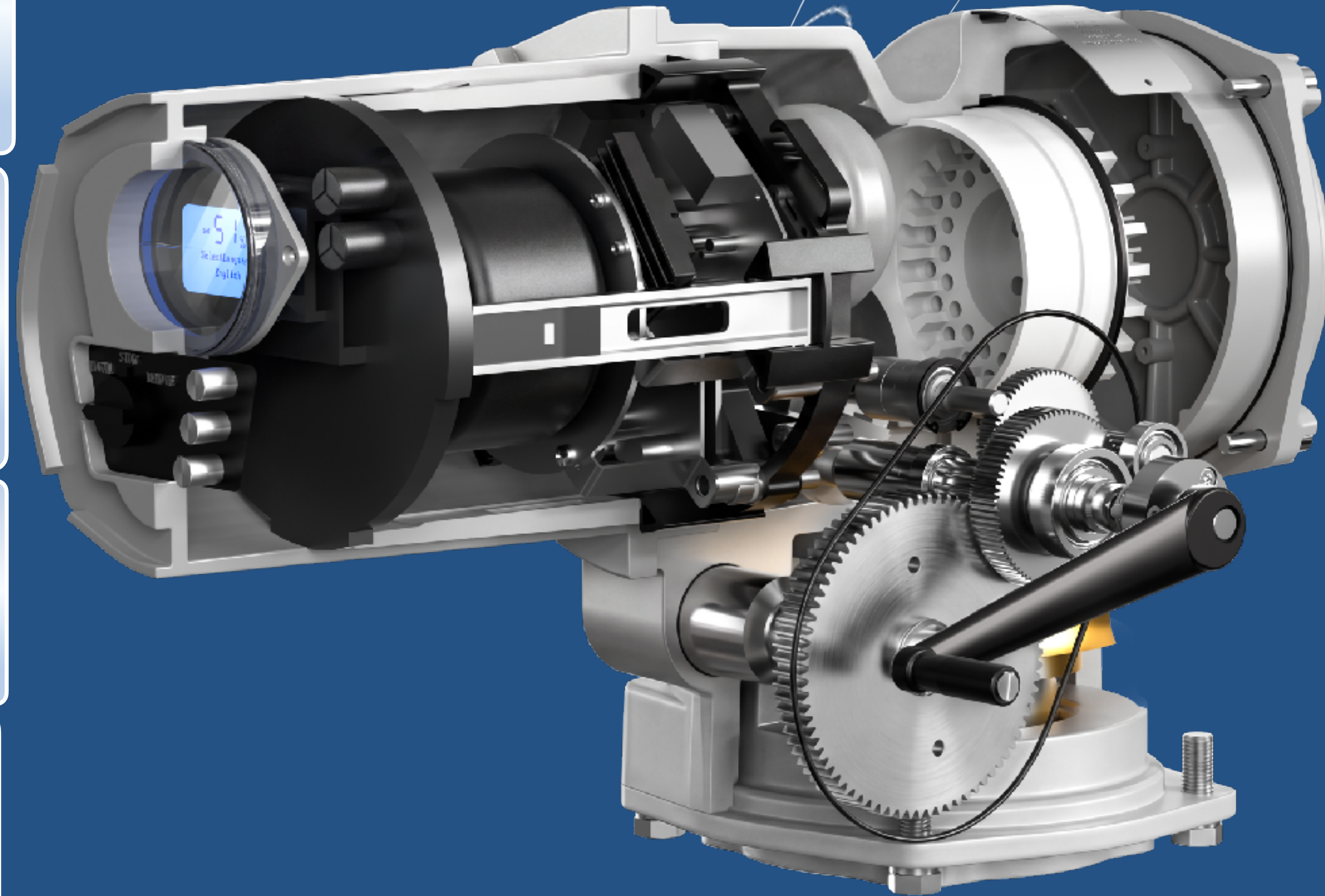



AVAR Smart

Quarter-turn

Electric Valve Actuator

On/Off & Modulating Technical Support



GREATORK Electric Actuator Product Series

AVAR Smart Quarter-turn Electric Valve Actuator

The economical quarter turn electric actuator achieves an ideal balance between outstanding cost-effectiveness and core intelligent functions. This series is optimally designed based on the mature AVAT platform, effectively controlling costs through precise simplification of structure and functions, while retaining key intelligent configurations including non-intrusive commissioning, LCD screen and menu-driven operation.

Its valve position measurement adopts a highly reliable absolute encoder design, ensuring precise position control and long service life, which makes the economical series demonstrate significant performance and technical advantages among products at the same price level. Despite being positioned as an economical type, it is essentially a fully functional intelligent electric actuator.

Relying on its excellent practicality and cost-effectiveness, the economical series has become an ideal choice for large-scale applications in environmental protection and industrial fields such as desulfurization, denitrification, and water treatment.



Electric Actuator features:

In order to meet the demand of the market, Greatork has developed AVAR series quarter-turn electric actuator on the basis of AVAT series actuator. AVAR series actuator with the torque range from 50Nm to 500Nm, has the characteristics of smart, simple structure, complete function, reliable quality and competitive price.

AVAR Smart

Quarter-turn

Electric Valve Actuator



AVAR reserved functions of AVAT as listed:

- Non-intrusive design
 - Auto phase correction
 - Instantaneous reversal protection
 - Motor overheating protection
 - 4 sets of indication contacts
 - Analogue position control (option)
 - Fieldbus (option)
- 1. Button setting of parameters
AVAR actuator changes the parameter setting mode – it uses push buttons to set parameters, replacing the infrared setting tool used by AVAT.
 - 2. High-brightness industrial LCD display
AVAR series adopts a high-brightness, large-screen LCD display that clearly shows Chinese or English menus.
 - 3. Absolute encoder measurement of valve position
AVAR range actuator uses an advanced 12-bit Hall magnetic absolute encoder. It can accurately record valve position without battery when power is off. The valve position measurement accuracy reaches 0.08°.

The Internal Structure of **AVAR** Actuator

1. Liquid crystal Display

Dot Matrix LCD with blue backlight can clearly show Chinese or English menu. Real-time valve position, torque value, actuator current status and fault information will also be shown. At the bottom of the screen, there are three high brightness diodes which can indicate open, close and middle position of valve.

2. Mainboard

The adoption of SOC chip and high - integrated circuit design provide actuator with multiple functions such as fault detection, self - protection and alarm. Therefore, the reliability of actuator is improved.

3. Valve position control

Hall absolute encoder driven by mainshaft can measure the valve position accurately.

4. Button

There are four buttons called local/remote/menu button, open/plus button, close/minus button and stop/enter button on the actuator. User can set up various functions of actuator easily with these buttons.

5. Motor

Greatork uses high torque, low inertia squirrel cage motor with F class enamel-insulated wire and two internal thermal switches.

6. Power supply board

The electronic components used to control motor, power supply and other parts are integrated on the power supply board.

8. Handle

Turning the handle can switch the actuator to manual status when manual operation is needed. The handle can be locked by padlock to prohibit unnecessary manual setting.

9. Worm and worm shaft

Two-stage worm reducer has large transmission ratio, low noise (50dB is the highest) and self-lock functions.

7. Handwheel

Actuator has a handwheel, which can operate the valve by user when power is off. The dimension of the handwheel is designed for labor saving.

12. Terminal Compartment

The double-seal design of the terminal compartment can protect the internal electric components from the outside hazardous gas during site wiring.

11. Base

The installation dimension of the base conforms to ISO5211 standard and the drive bush can be machined according to the requirement of user.

10. Clutch

Clutch is used to switch manual and electric operation.

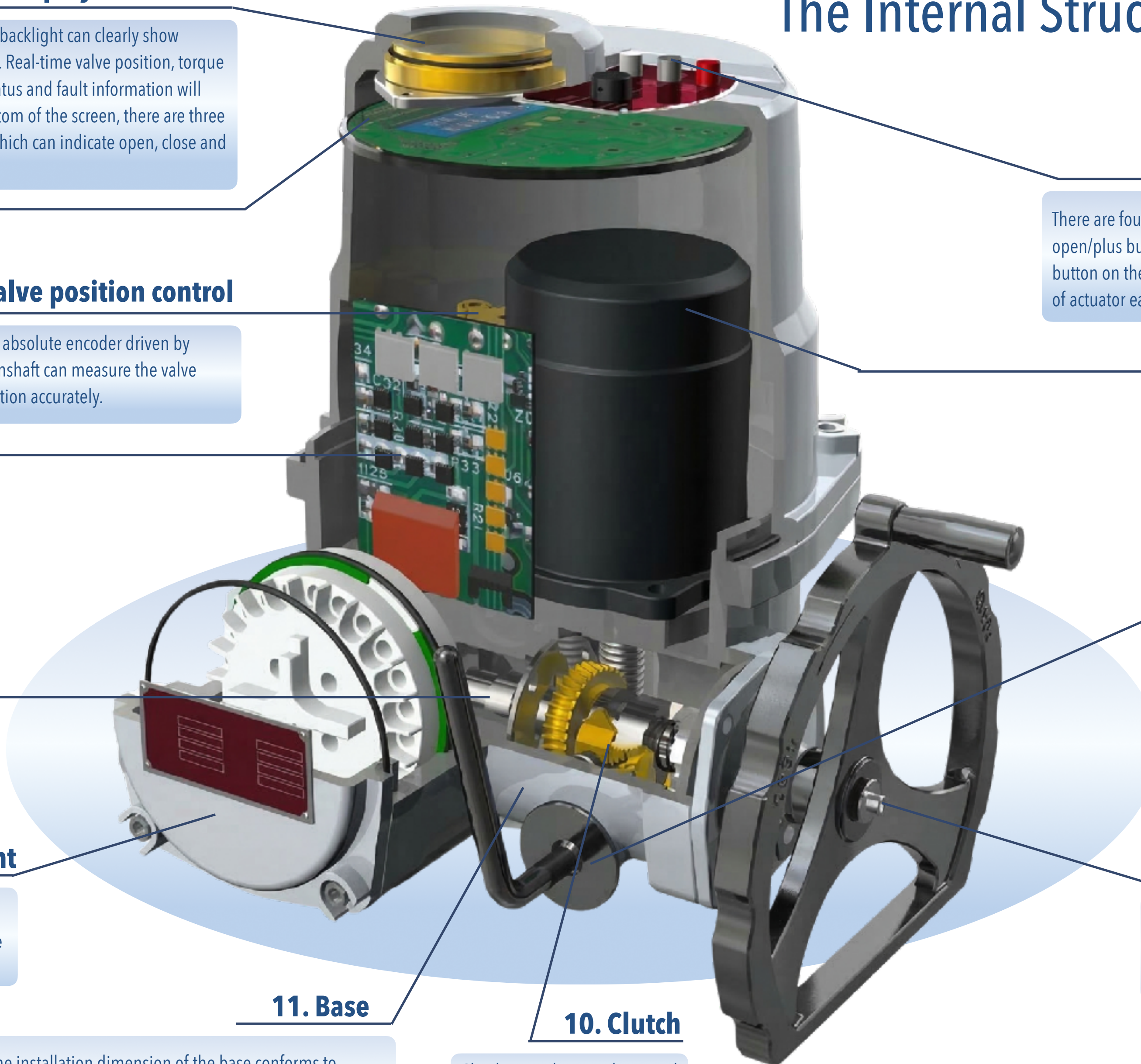

Quarter-turn On/Off

Electric Valve Actuator

AVAR Series Performance Data (380V 3Phase 50Hz On/Off)											
Model	Specification	Flange (ISO 5211)	Time (S)	Torque (Nm)	Motor Poles	Rated Current (A)	Starting Current (A)	Rated Power (KW)	Power Factor	Efficiency (%)	Weight (KG)
AVAR200	AVAR5	F05/F07	20	50	4	0.50	1.60	0.05	0.83	57	14
	AVAR10	F05/F07	20	100	4	0.53	1.60	0.05	0.83	57	14
	AVAR15	F05/F07	20	150	4	0.56	1.60	0.05	0.83	57	14
	AVAR20	F05/F07	20	200	4	0.62	1.60	0.05	0.83	57	14
AVAR500	AVAR30	F07/F10	30	300	4	1.03	2.20	0.08	0.74	61	17
	AVAR40	F07/F10	30	400	4	1.08	2.20	0.08	0.74	61	17
	AVAR50	F07/F10	30	500	4	1.12	2.20	0.09	0.74	61	17

AVAR Series Performance Data (380V 3Phase 60Hz On/Off)											
Model	Specification	Flange (ISO 5211)	Time (S)	Torque (Nm)	Motor Poles	Rated Current (A)	Starting Current (A)	Rated Power (KW)	Power Factor	Efficiency (%)	Weight (KG)
AVAR200	AVAR5	F05/F07	17	50	4	0.51	1.50	0.05	0.72	67	14
	AVAR10	F05/F07	17	100	4	0.54	1.50	0.05	0.72	67	14
	AVAR15	F05/F07	17	150	4	0.58	1.50	0.05	0.72	67	14
	AVAR20	F05/F07	17	200	4	0.63	1.50	0.05	0.72	67	14
AVAR500	AVAR30	F07/F10	26	300	4	0.95	1.90	0.08	0.75	64	17
	AVAR40	F07/F10	26	400	4	1.02	1.90	0.08	0.75	64	17
	AVAR50	F07/F10	26	500	4	1.12	1.90	0.08	0.75	64	17

AVAR Series Performance Data (220V 1Phase 50Hz On/Off)											
Model	Specification	Flange (ISO 5211)	Time (S)	Torque (Nm)	Motor Poles	Rated Current (A)	Starting Current (A)	Rated Power (KW)	Power Factor	Efficiency (%)	Weight (KG)
AVAR200	AVAR5	F05/F07	20	40	4	0.86	1.20	0.03	0.96	52	14
	AVAR10	F05/F07	20	60	4	0.86	1.20	0.03	0.96	52	14
	AVAR15	F05/F07	20	80	4	0.86	1.20	0.03	0.96	52	14
	AVAR20	F05/F07	20	100	4	0.86	1.20	0.03	0.96	52	14
AVAR500	AVAR30	F07/F10	30	150	4	1.30	2.20	0.05	0.96	58	17
	AVAR40	F07/F10	30	175	4	1.30	2.20	0.05	0.96	58	17
	AVAR50	F07/F10	30	220	4	1.30	2.20	0.05	0.96	58	17

AVAR Series Performance Data (220V 1Phase 60Hz On/Off)											
Model	Specification	Flange (ISO 5211)	Time (S)	Torque (Nm)	Motor Poles	Rated Current (A)	Starting Current (A)	Rated Power (KW)	Power Factor	Efficiency (%)	Weight (KG)
AVAR200	AVAR5	F05/F07	17	40	4	0.90	1.10	0.04	0.94	70	14
	AVAR10	F05/F07	17	60	4	0.90	1.10	0.04	0.94	70	14
	AVAR15	F05/F07	17	80	4	0.90	1.10	0.04	0.94	70	14
	AVAR20	F05/F07	17	100	4	0.90	1.10	0.04	0.94	70	14
AVAR500	AVAR30	F07/F10	26	150	4	1.50	2.10	0.05	0.93	62	17
	AVAR40	F07/F10	26	175	4	1.50	2.10	0.05	0.93	62	17
	AVAR50	F07/F10	26	220	4	1.50	2.10	0.05	0.93	62	17

Note:Wiring and airbreak switch selection should refer to current(A) data of actuators.

Modulating

AVARM Series Performance Data (380V 3Phase 50Hz Modulating)

Model	Specification	Flange (ISO 5211)	Time (S)	Torque (Nm)	Motor Poles	Rated Current (A)	Starting Current (A)	Rated Power (KW)	Power Factor	Efficiency (%)	Weight (KG)
AVARM200	AVARM5	F05/F07	20	50	4	0.48	1.50	0.05	0.80	60	14
	AVARM10	F05/F07	20	75	4	0.50	1.50	0.05	0.80	60	14
	AVARM15	F05/F07	20	100	4	0.52	1.50	0.05	0.80	60	14
	AVARM20	F05/F07	20	140	4	0.56	1.50	0.05	0.80	60	14
AVARM500	AVARM30	F07/F10	30	180	4	0.92	2.10	0.09	0.75	63	17
	AVARM40	F07/F10	30	240	4	0.96	2.10	0.09	0.75	63	17
	AVARM50	F07/F10	30	300	4	1.02	2.10	0.10	0.75	63	17

AVARM Series Performance Data (380V 3Phase 60Hz Modulating)

Model	Specification	Flange (ISO 5211)	Time (S)	Torque (Nm)	Motor Poles	Rated Current (A)	Starting Current (A)	Rated Power (KW)	Power Factor	Efficiency (%)	Weight (KG)
AVARM200	AVARM5	F05/F07	17	50	4	0.50	1.40	0.05	0.74	68	14
	AVARM10	F05/F07	17	75	4	0.52	1.40	0.05	0.74	68	14
	AVARM15	F05/F07	17	100	4	0.55	1.40	0.05	0.74	68	14
	AVARM20	F05/F07	17	140	4	0.60	1.40	0.05	0.74	68	14
AVARM500	AVARM30	F07/F10	26	180	4	0.86	1.80	0.09	0.78	65	17
	AVARM40	F07/F10	26	240	4	0.93	1.80	0.09	0.78	65	17
	AVARM50	F07/F10	26	300	4	1.05	1.80	0.09	0.78	65	17

AVARM Series Performance Data (220V 1Phase 50Hz Modulating)

Model	Specification	Flange (ISO 5211)	Time (S)	Torque (Nm)	Motor Poles	Rated Current (A)	Starting Current (A)	Rated Power (KW)	Power Factor	Efficiency (%)	Weight (KG)
AVARM200	AVARM5	F05/F07	20	30	4	0.76	1.10	0.03	0.97	68	14
	AVARM10	F05/F07	20	40	4	0.76	1.10	0.03	0.97	68	14
	AVARM15	F05/F07	20	55	4	0.76	1.10	0.03	0.97	68	14
	AVARM20	F05/F07	20	70	4	0.76	1.10	0.03	0.97	68	14
AVARM500	AVARM30	F07/F10	30	100	4	1.22	2.00	0.05	0.95	63	17
	AVARM40	F07/F10	30	140	4	1.22	2.00	0.05	0.95	63	17
	AVARM50	F07/F10	30	180	4	1.22	2.00	0.05	0.95	63	17

AVARM Series Performance Data (220V 1Phase 60Hz Modulating)

Model	Specification	Flange (ISO 5211)	Time (S)	Torque (Nm)	Motor Poles	Rated Current (A)	Starting Current (A)	Rated Power (KW)	Power Factor	Efficiency (%)	Weight (KG)
AVARM200	AVARM5	F05/F07	17	30	4	0.82	1.00	0.04	0.95	71	14
	AVARM10	F05/F07	17	40	4	0.82	1.00	0.04	0.95	71	14
	AVARM15	F05/F07	17	55	4	0.82	1.00	0.04	0.95	71	14
	AVARM20	F05/F07	17	70	4	0.82	1.00	0.04	0.95	71	14
AVARM500	AVARM30	F07/F10	26	100	4	1.30	1.90	0.05	0.93	64	17
	AVARM40	F07/F10	26	140	4	1.30	1.90	0.05	0.93	64	17
	AVARM50	F07/F10	26	180	4	1.30	1.90	0.05	0.93	64	17

Note:Wiring and airbreak switch selection should refer to current(A) data of actuators.

GREATORK Electric Actuator Customization Capabilities

Based on Proven Technical Assets From our R&D Center

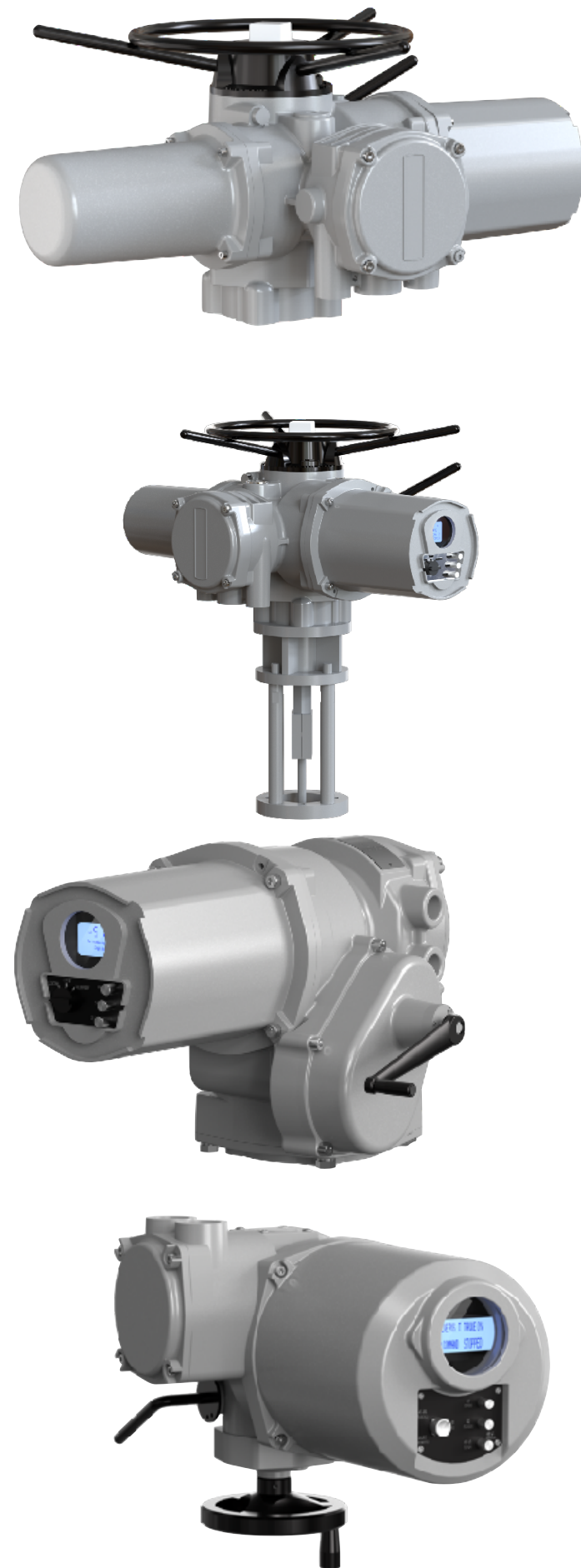

Custom Product

The Engineering Process | A reliable roadmap from concept to delivery

01



Requirement Discovery

Technical consultation and site analysis.

02



R&D & Simulation

3D modeling and stress testing.

03



Bespoke Manufacturing

Flexible assembly in our 53,000 sqm factory.

04



Quality Assurance

Certification testing and global delivery

Customization Capabilities , Please visit our support website



<https://www.greatorkpartners.com/customization>

Technical Support



partner@greatorkpartners.com



whatsapp

+86 15601713000 Eric

+86 13901803381 David



Engineered to Replace. Built to Outperform

Oil & Gas | Power | Port & Terminal | Water Treatment | Smelting & Building Materials | General Industry

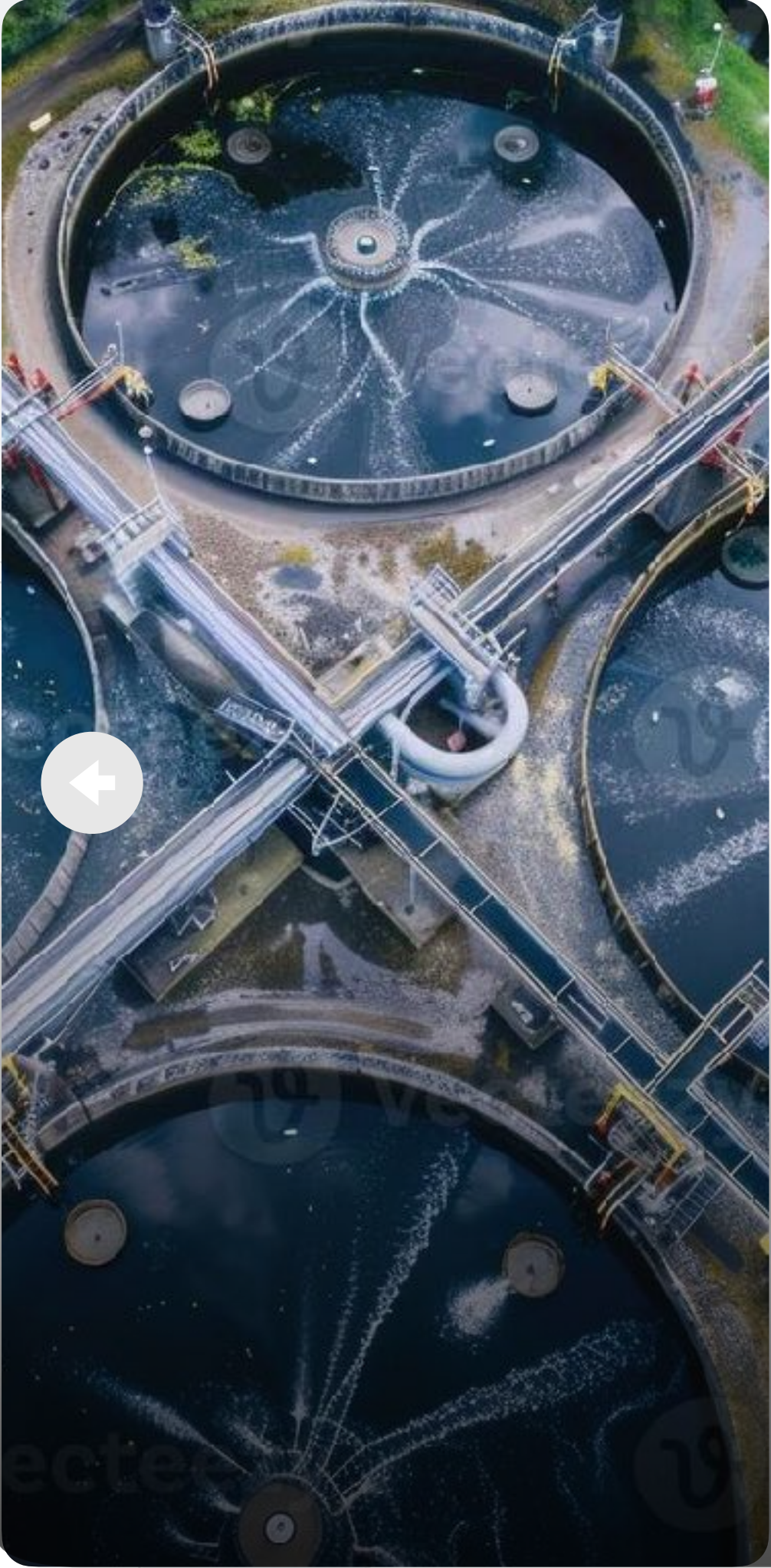

Partners Project Cases

[More Cases](#)

Trusted across the world's most demanding industries





Project Country : Russia
 Project Owner : Gazprom (PAO Gazprom)
 Product(s) Used : Electric Actuators (AVA/AVAT series)
 Quantity Used : 172 Units (Highest volume in 2022)

Industry Highlights :

- **Entry into High-Barrier Market:** Gazprom has some of the world's most stringent technical entry barriers. Being selected for their pipeline projects proves that GREATORK meets the rigorous Russian GOST standards and the specific safety requirements of the global oil and gas elite.
- **Extreme Low-Temperature Resilience:** Russian energy infrastructure often operates in sub-zero Arctic and Siberian conditions. GREATORK actuators are designed with specialized low-temperature seals and heating elements to ensure reliable operation at temperatures as low as -50°C.
- **Critical Pipeline Safety:** In high-pressure natural gas transmission, any actuator failure can lead to severe consequences. Our products provide the rapid, fail-safe response necessary to maintain the integrity of long-distance energy corridors.

Solutions :

- **Explosion-Proof & Flame-Proof (Ex db II CT4 Gb):** Certified for hazardous areas where explosive gases are present, ensuring the highest level of safety for gas compression and valve stations.
- **Non-Intrusive Infrared Setup:** Allows for commissioning and diagnostics without opening the enclosure, which is critical for preventing internal condensation and maintaining the hermetic seal in harsh Russian winters.
- **High-Precision Absolute Encoder:** Provides **0.5% measurement accuracy** without the need for battery backup, ensuring that even after a power outage in remote Siberian regions, the valve position is accurately remembered.





Project Country : China & Russia
 Project Owner : PipeChina
 Product(s) Used : Electric Actuators (AVA/AVAT series)
 Quantity Used : 105 Units

Industry Highlights :

- **Strategic Energy Corridor:** As one of the world's longest and most significant energy pipelines, the East Route requires the highest level of reliability. GREATORK's 105 units support the automated flow control across diverse terrains, ensuring a steady supply of natural gas between Russia and China.
- **Unmatched Technical Standards:** This project demands compliance with both international and national petroleum standards. GREATORK actuators were selected for their ability to provide precise, fail-safe operation in the high-pressure environments characteristic of major transmission pipelines.
- **Harsh Terrain & Remote Control:** Deployed in remote regions where accessibility for maintenance is limited, our actuators utilize advanced fieldbus communication and self-diagnostic features to allow for reliable remote monitoring and control from centralized dispatch centers.

Solutions:

- **Advanced Fieldbus Communication (Modbus/Profibus):** Integrated with the pipeline's SCADA system, these actuators enable real-time data acquisition and remote diagnostic capabilities, essential for managing a cross-border network.
- **High-Definition OLED Display & Data Logging:** Features clear status visibility and historical data storage (over 1 million data points), allowing for predictive maintenance and detailed analysis of valve performance without site visits.
- **Robust Non-Intrusive Design:** Infrared setting technology ensures that the flame-proof enclosure remains sealed during setup, preventing any risk of ignition in the high-pressure gas environment and protecting internal electronics from environmental degradation.





Project Country : China- & Russia

Project Owner :

PipeChina (National Oil and Gas Pipeline Network Group)

Product(s) Used : Electro-Hydraulic Actuator | Gas-over-oil (GOA) | Electro Hydraulic Actuator

Industry Highlights :

- **Extreme Scale:** The China-Russia Eastern Line spans **5,111 km** within China, passing through 9 provinces. Line 4 (Turpan-Zhongwei) stretches **1,745 km**.
- **Technical Benchmarking:** Utilizes **1,422 mm** (Eastern Line) and **1,219 mm** (Line 4) ultra-large diameters with X80M high-grade steel and **12 MPa** high-pressure ratings.
- **Extreme Environment:** Equipment must operate flawlessly in extreme cold reaching **-46°C** (Eastern Line) and harsh desert/mountainous terrains.
- **Localization Milestone:** GREATORK serves as a core supplier for the localization of critical high-end actuation equipment for China's national energy pulse.

Solutions:

- **Extreme Temperature Resistance:** Customized seals and hydraulic fluids enabling stable operation from -46°C to -60°C.
- **Fail-Safe Reliability:** For Line 4, GOA units were deployed at 18 valve stations to ensure emergency shutdown (ESD) capabilities using the pipeline's own gas pressure as the power source.
- **Smart Integration:** Electric actuators feature non-intrusive infrared setting and OLED displays for real-time diagnostics in remote valve chambers.
- **Full Lifecycle Service:** Provided high-level coordination with various project management divisions to ensure perfect delivery and ongoing maintenance across 44+ valve chambers.





Project Country : Pakistan
 Project Owner : Uch Power (Private) Ltd
 Product(s) Used : Electric Actuators (AVA/AVAT series)
 Quantity Used : 40 Units

Industry Highlights :

- **Critical Energy Infrastructure:** Uch Power Plant is a strategic asset for Pakistan's national grid. GREATORK provides essential actuation solutions for its combined cycle operations, ensuring high availability and power stability.
- **Harsh Desert Environment Adaptability:** Located in the Dera Murad Jamali region, the plant faces extreme ambient temperatures and dust. Our actuators' **IP68** sealing and robust thermal design are essential for reliable performance in these conditions.
- **High-End Replacement Strategy:** By supplying actuators and critical spares to a plant previously dominated by international giants, GREATORK reinforces its position as a "Complete Replacement" for premium Western brands.

Solutions:

- **Strategic Spare Parts Support:** Provided customized electrical and mechanical spares to ensure zero-downtime maintenance for the plant's automated valve systems.
- **Non-Intrusive Smart Diagnostics:** The actuators feature infrared setting and OLED displays, allowing engineers to check status and torque history without opening covers, preventing dust ingress into the electronics.
- **Absolute Encoder Precision:** Ensures 0.5% measurement accuracy for critical steam and water cycle control, with valve position memory retained even during sudden power fluctuations.



UCH Power (Private) Limited





Project Country : India
Project Owner : Vedanta Group Company / SEPCOIII Electric Power Construction Corporation
Product(s) Used : Electric Actuators (AVA/AVAT series)
Quantity Used : 131 Units

Industry Highlights :

- **Massive Scale Integration:** The JHARSUGUDA project is a giant power complex featuring nine 135MW units. GREATORK's supply of 131 units highlights our capacity to manage complex, large-scale simultaneous deployments across multiple power generation blocks.
- **Strategic Support for Global EPCs:** Being selected by SEPCOIII for their critical Indian projects proves that GREATORK is a Tier-1 actuator supplier capable of meeting the rigorous quality, documentation, and international standard requirements of world-class engineering firms.
- **High-Efficiency Industrial Power:** As a Captive Power Plant (CPP) supporting one of the world's largest aluminum smelters (Vedanta), the reliability of GREATORK actuators is essential for ensuring an uninterrupted power supply to critical industrial production lines.

Solutions:

- **Precision Measurement in High-Heat Zones:** Utilizing absolute encoders with **0.5% measurement accuracy**, our actuators ensure precise valve control in the plant's steam and water cycles, even in the intense heat characteristic of Indian industrial zones.
- **Non-Intrusive Smart Setup:** The infrared setting technology allows engineers to perform commissioning without opening the electrical cover, protecting the sensitive electronic control units from the pervasive coal dust and fly ash found in thermal plants.
- **Advanced Protection for Unstable Grids:** Features built-in motor overheating, phase loss, and overcurrent protection, which are vital for maintaining equipment integrity in regions where power grid fluctuations are common.





Project Country : China
 Project Owner : Liaoning Port Group
 Product(s) Used : Electric Actuators (AVA/AVAT series)
 Quantity Used : 92 Units

Industry Highlights :

- **Corrosive Marine Environment:** Yingkou Port is located on the Liaodong Bay. The actuators are exposed to high salinity, sea fog, and moisture. GREATORK's **IP68** double-sealing and specialized marine-grade anti-corrosion coating ensure the internal electronic components are fully protected from salt spray corrosion.
- **Oil & Chemical Safety Standards:** As the terminal handles volatile oil and chemical products, all actuators are required to meet the highest explosion-proof standards (**Ex db II CT4 Gb**). Our products ensure zero-spark operation in hazardous zones.
- **Winter Low-Temperature Resilience:** Northeast China experiences extreme cold in winter. GREATORK actuators are engineered to operate reliably at temperatures as low as **-30°C to -40°C** (with custom options down to -60°C), ensuring the port's energy logistics remain uninterrupted during the freezing months.

Solutions:

- **Non-Intrusive Infrared Setting:** Maintenance can be performed via an infrared setter without opening any electrical covers, which is vital for maintaining the equipment's seal in the humid, salty air of the port.
- **Precise Absolute Encoder:** Provides 0.5% accuracy for valve position monitoring. This high precision is essential for the automated loading and unloading processes, preventing overfills or leaks during cargo transfer.





Project Country : Thailand

Project Owner : Metropolitan Waterworks Authority

(MWA) Product(s) Used : Electric Actuators (AVA/AVAT series)

Quantity Used : 224 Units

Industry Highlights :

- **High-Volume Municipal Deployment:** Serving a national-level water authority like Thailand's MWA requires meeting strict public utility standards. Deploying 224 units in a single project framework demonstrates GREATORK's capacity for large-scale municipal automation.
- **Crucial Urban Water Stability:** As the primary water provider for Bangkok's millions of residents, the MWA demands zero-failure performance. GREATORK actuators ensure the precise regulation of flow and pressure, preventing water hammers and ensuring stable water supply 24/7.
- **Tropical Environment Resilience:** Bangkok's humid and high-temperature climate poses challenges to electronic equipment. Our actuators' **IP68** sealing and non-intrusive design are essential for maintaining long-term integrity in damp water plant environments.

Solutions:

- **IP68 Waterproofing & Anti-Condensation:** Designed to thrive in high-humidity pump rooms and valve pits, ensuring that moisture and condensation do not enter the electrical compartment, which is critical for urban water safety.
- **Absolute Encoder Precision:** Provides **0.5% measurement accuracy**, allowing MWA engineers to monitor and control valve positions remotely via the central control room with high confidence and precision.
- **Non-Intrusive Infrared Commissioning:** Allows for rapid parameter setting and diagnostics without opening the actuator cover, significantly reducing maintenance time and preventing environmental contaminants from affecting the electronics.





Project Country : South Africa
Project Owner : Various Municipal Water Boards / DEMCA (Pty) Ltd
Product(s) Used : GREATORK Intelligent Electric Actuators
Quantity Used : 71 Units

Industry Highlights :

- **Strategic African Infrastructure:** South Africa is a key market for water scarcity management. GREATORK's participation in these projects highlights our ability to provide robust automation solutions for essential water delivery systems in the African region.
- **Adaptability to Remote Locations:** Many water facilities in South Africa are situated in remote areas with limited technical support. The self-diagnostic and high-reliability features of GREATORK actuators ensure long-term operation with minimal on-site intervention.
- **Resilience Against Power Fluctuations:** In regions where power grid stability can be an issue, our actuators' built-in protection (phase loss, motor overheating) and non-battery absolute encoders ensure that valve positions are accurately maintained and monitored.

Solutions:

- **IP68 Protection for All-Weather Operation:** The highest grade of waterproof and dustproof performance ensures the actuators operate reliably in both underground pits and outdoor exposed locations common in South African water networks.
- **Non-Intrusive Setting for Easy Maintenance:** Parameters are set via an infrared setter without opening the electrical cover, which is critical for protecting sensitive internal electronics from dust and moisture in the field.
- **Precise Flow Control (0.5% Precision):** Using absolute encoders to provide high-accuracy feedback, ensuring the efficient distribution and pressure management required for large-scale water networks.





Project Country : Malaysia
 Project Owner : Dostek Engineering Sdn Bhd
 Product(s) Used : GREATORK Intelligent Electric Actuators
 Quantity Used : 400 Units

Industry Highlights :

- **Broad Regional Impact:** Through Dostek, GREATORK actuators have been deployed in numerous water treatment plants across **Penang, Melaka, and Sarawak**. This widespread application reinforces our brand's dominant position in both Peninsular and East Malaysia.
- **Tropical Humidity & Flood Protection:** Malaysia's equatorial climate requires equipment with superior sealing. Our actuators' **IP68** protection (submersible up to 7 meters for 72 hours) is a critical feature for water plants often located in low-lying, flood-prone areas.
- **Standardized Automation Solution:** Dostek utilizes GREATORK as a standardized actuation solution for their turnkey water projects, highlighting the ease of integration and the high compatibility of our products with diverse international valve brands.

Solutions:

- **Corrosion-Resistant Housing:** Features high-grade powder coating and aluminum alloy housing, providing excellent resistance to the chemical fumes (such as chlorine) commonly found in water disinfection areas.
- **Absolute Encoder Reliability:** The non-battery absolute encoder ensures that valve position data is never lost, even during the frequent tropical thunderstorms and subsequent power outages common in the region.
- **Widespread Local Application through Partnership:** Through the technical expertise and service network of **Dostek**, GREATORK has successfully permeated numerous landmark projects across Malaysia, including:
 Sungai Pinang WTP (Penang)
 Long Lama WTP (Sarawak)
 Spg Bekoh Pumping Station (Melaka)
 Selanda Booster Station (Melaka)



Dostek Engineering Sdn. Bhd.
 (662419-H)





Project Country : China
 Project Owner : Baowu Steel Group (Baosteel)
 Product(s) Used : Electric Actuators (AVA/AVAT series)
 Quantity Used : 420 Units

Industry Highlights :

- **Top-Tier Global Endorsement:** Baosteel is the benchmark for the global steel industry. Being integrated into their production lines—which require extremely high stability and precision—serves as a premier technical endorsement, proving that GREATORK products can **completely replace** premium Western brands in high-end metallurgical applications..
- **Smart Manufacturing Integration:** Baosteel leads the "Smart Steel" movement. GREATORK actuators' advanced fieldbus communication and diagnostic capabilities allow for seamless integration into their highly centralized control systems, supporting predictive maintenance and reducing unexpected downtime.
- **High-Temperature & Dust Resistance:** The steel-making process involves intense radiant heat and conductive dust. Our actuators' robust aluminum/cast iron housing and **IP68** double-sealing ensure that internal electronics remain protected even in the harshest areas of the blast furnace or continuous casting sections.

Solutions:

- **Advanced Communication (Profibus/Modbus):** Fully compatible with the complex automation networks used in Baosteel's modern plants, providing high-speed data transmission for real-time valve status monitoring.
- **Absolute Encoder with 0.5% Precision:** Provides pinpoint accuracy for critical flow control in water treatment and cooling systems, essential for maintaining the steel's metallurgical properties during the cooling phase.
- **Non-Intrusive Setting via OLED Interface:** Allows engineers to adjust limits and torque settings via an infrared tool without opening the electrical box, preventing conductive iron dust from entering the control compartment—a common cause of failure in older systems.





Project Country : Indonesia
 Project Owner : OKI Pulp & Paper Mills (Asia Pulp & Paper - APP Group)
 Product(s) Used : Electric Actuators (AVA/AVAT series)
 Quantity Used : 57 Units

Industry Highlights :

- **World-Class Scale and Standards:** OKI Pulp & Paper is a flagship project in the global paper industry. Being integrated into such a large-scale facility proves that GREATORK actuators can meet the stringent requirements of international industrial giants for high-capacity, automated production.
- **Corrosive & Humid Environment Resilience:** Pulp and paper manufacturing involves high humidity and exposure to chemicals (such as bleaching agents). GREATORK actuators, with their **IP68** double-sealed enclosure and high-grade anti-corrosion coating, are designed to survive and thrive in these aggressive environments.
- **Complex Flow Control:** The paper-making process requires precise regulation of pulp consistency, chemical dosing, and water treatment. These 57 units provide the necessary accuracy and rapid response to ensure consistent product quality and process efficiency.

Solutions:

- **Absolute Encoder (0.5% Accuracy):** Provides high-precision valve position measurement without needing battery backup. This is vital for the continuous 24/7 production cycle in paper mills, where even minor positioning errors can affect the final paper grade.
- **Non-Intrusive Setting via Infrared Tool:** Allows parameter adjustment without opening the electrical cover, protecting the sensitive internal electronics from the highly humid and potentially corrosive atmosphere of the mill.
- **Real-Time Monitoring & Protection:** Includes protection functions such as motor overheating, valve jamming, and torque protection. These features, combined with the clear OLED display, allow for rapid troubleshooting and minimize costly production downtime.





Project Country : Ecuador
Project Owner : HIVIMAR S.A.
Product(s) Used : GREATORK Intelligent Electric Actuators
Quantity Used : 152 Units

Industry Highlights :

- **Entry into the Latin American Market:** This collaboration with HIVIMAR marks GREATORK's successful penetration into the high-standard industrial market of Ecuador, representing our expanding footprint in South America
- **Strategic Brand Replacement:** HIVIMAR typically partners with top-tier global brands. GREATORK being selected for their industrial projects underscores our product's positioning as a "Complete Replacement" for European and American brands.
- **High Reliability in Complex Terrains:** Ecuador's diverse geography requires equipment that can handle varying altitudes and humidity levels, where GREATORK's IP68 protection and robust design excel.

Solutions:

- **Non-Intrusive Smart Configuration:** Parameters are set via infrared setters, ensuring the internal electronics remain sealed and protected from local environmental contaminants.
- **Precision Valve Control:** Using absolute encoders, the actuators provide 0.5% measurement accuracy, which is essential for the high-efficiency regulation required by HIVIMAR's industrial clients.
- **Intelligent Data Monitoring:** The high-definition OLED display and history logging allow onsite engineers to monitor torque and operating status in real-time, facilitating proactive maintenance.



All Project Cases

Browse our complete portfolio of global valve automation projects

INDUSTRY: **All Industries** | Oil & Gas | Power | Port & Terminal | Water Treatment | Smelting & Building Materials | General Industry

REGION: **All Regions** | Europe | Middle East | Asia Pacific | Americas | Africa



Russia - Oil & Gas

Gazprom Pipeline & Infrastructure Project

Electric Actuator

Strategic Natural Gas Pipelines in Russia. Delivered Electric Actuators (AVA/AVAT...

[View Details →](#)



Iraq - Oil & Gas

Iraqi Ministry of Oil - Refinery Automation & Spares

Electric Actuator

Downstream Oil Refinery Modernization in Iraq. Delivered Electric Actuators...

[View Details →](#)



Pakistan - Oil & Gas

PSO (Pakistan State Oil) Fuel Storage & Distribution...

Electric Actuator

Downstream Fuel Terminals in Pakistan. Delivered Electric Actuators (AVA/AVAT...

[View Details →](#)



China & Russia - Oil & Gas

China-Russia East Route Natural Gas Pipeline (Power of...

Electric Actuator

Strategic Cross-Border Natural Gas Pipeline. Delivered Electric Actuators...

[View Details →](#)



Iran - Oil & Gas

National Iranian Oil Company Infrastructure Projects

Electric Actuator

Upstream & Midstream Assets in Iran. NIOC. Delivered Electric Actuators...

[View Details →](#)



Ecuador - Oil & Gas

Petroecuador Oil Field Development & Automation

Electric Actuator

Upstream Oil Field Modernization in Ecuador. Delivered Electric Actuators...

[View Details →](#)

Trusted by Industry Leaders



Selected projects for the current industry focus, Please visit our support website



<https://www.greatorkpartners.com/project-cases/all>

Technical Support



partner@greatorkpartners.com



whatsapp

+86 15601713000 Eric
+86 13901803381 David



GP

GREATORK® Partner

www.greatorkpartners.com



Global Headquarters

Tefulong Group Co., Ltd.
Tefulong(Shanghai) Technologies Co., Ltd.

Factory Address: No.950, Feidu Road,
Pudong New Area, Shanghai, China



Global Partnerships Division

Ranshine (Shanghai) Energy Technologies Co., Ltd.

Partner Office Address: Room 408, Building 9,
Guiguoyuan
No.471 Guiping Road, Xuhui District, Shanghai, China.



Global Partnerships Mail

partner@greatorkpartners.com



Global Service Hotline

whatsapp

+86 15601713000 Eric
+86 13901803381 David



GREATORK Partner